

MAMIYA

AUTO-LUX 35

**OWNER'S
MANUAL**

MAMIYA AUTO-LUX 35

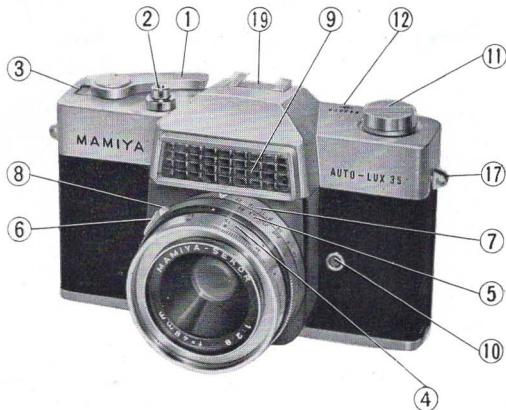

Front View

- ① Film Advance Lever
- ② Shutter Release Button
(with Cable Release and Self-timer Socket)
- ③ Automatic Frame Counter
(Self Re-setting)
- ④ Focusing Ring
(marked in feet and meters)
- ⑤ Shutter Speed Ring
- ⑥ Aperture Adjusting Knob
- ⑦ Lens Aperture Ring
- ⑧ B (Bulb) Setting Lever
- ⑨ Exposure Meter Window
- ⑩ Flash Terminal
- ⑪ Rewinding Knob
- ⑫ Focus Indicating Mark

Rear View

- ⑬ Film Sensitivity Selector Lever
- ⑭ Rewind Button
- ⑮ Tripod Socket
- ⑯ Back Cover Lock
- ⑰ Neck Strap Loops
- ⑱ Viewfinder
- ⑲ Accessory Shoe
- ⑳ Take-up Spool
- ㉑ Sprocket
- ㉒ Film Chamber
- ㉓ Light Baffle

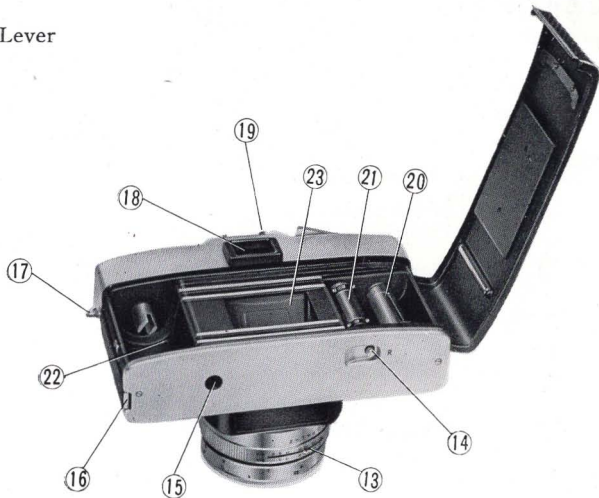

MAMIYA AUTO-LUX FEATURES

- TYPE:** 35mm Single Lens Reflex
- EE MECHANISM:** Automatic exposure system in which the light meter, shutter and aperture are cross-coupled to give proper exposure by simply pointing the camera at the subject and pressing the shutter release button.
- EE RANGE:** From EV 7 to 17 for ASA 100 film
- FILM SENSITIVITY:** ASA 10 to 400
DIN 11 to 27
- SHUTTER:** Speeds B, 1/15, 1/30, 1/60, 1/125, 1/250 and 1/500 second
- APERTURE:** A (Auto), 2.8, 4, 5.6, 8, 11, 16, 22 click stop
Manual—by disengaging Auto and making adjustments manually.
Meter can also be used independently.
- VIEW FINDER:** Pentagonal with micro dia-prism center and incorporated meter pointer.
The mirror is instant return, non-shock type.
- FILM ADVANCE:** One stroke of 180° and a 24° action position.
- LENS:** MAMIYA SEKOR 48mm, F 2.8;
3 group, 3 element composition;
amber spectra coated and threaded for 40.5mm filters.

FLASH: X contact-electronic flash can be used at all speeds. Flash bulbs as noted in instructions.

DIMENSIONS: 135 mm × 75 mm × 76 mm, 690 g.

At the instant of photographing, the following seven actions are performed and the image in the finder disappears only during the exposure.

1. Shutter vanes close
2. Aperture is changed to proper size
3. Mirror goes up
4. Shutter is released
5. Mirror comes down
6. Aperture opens
7. Shutter vanes open

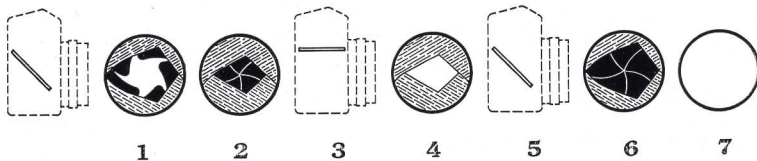

OPERATING INSTRUCTIONS

Before operating your Mamiya Auto-Lux 35, read the following pages carefully. Understanding the function of each part of the camera will lead to satisfactory performance and pictures you will be proud of. The design of the Auto-Lux 35 makes it convenient and easy to use.

FILM ADVANCE LEVER

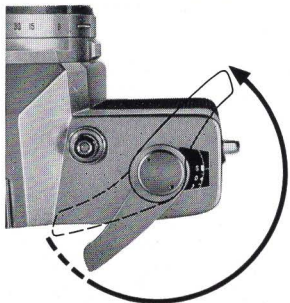

When the film advance lever ① is turned until it stops, the film is advanced one frame and the shutter is cocked.

At the same time, the automatic frame counter ③ moves one division.

When the shutter button ② is pressed the shutter actuates and it is possible to turn the film advance lever again.

Precautions

- Unless the lever is turned completely, it cannot return to its original position.
- Film cannot be advanced in small steps.

- 5 ● During film advance, the shutter button cannot be pressed.

- Film advancing is not possible while the shutter button is being pressed. The film advance lever ① has a spare angle of 24° . During picture taking, pull it out to this position to make the next turning easier. Cable release or self-timer can be attached to the shutter button.

LOAD FILM

1. Pull slide lock ⑩ and open the back. Pull out rewind knob ⑪ and place film cartridge in film chamber. Return rewind knob ⑪ to former position. If knob floats, turn it right or left to seat it. When the back cover is opened, never touch the light baffle ⑲. When the light baffle is deformed for any reason, incorrect focusing or light leakage results.

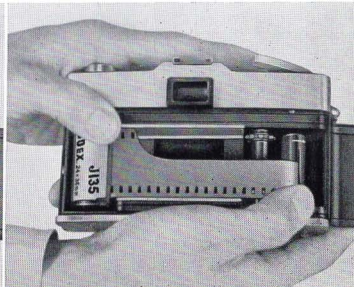
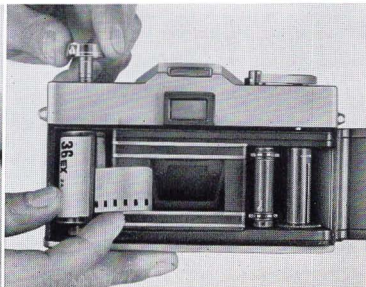

2. Insert film end into slit of take-up spool. If necessary rotate take-up spool until slit is in proper position to insert film. Then turn spool in direction of arrow and wind one turn of film. Assure that sprocket teeth engage film perforations.
3. Take up film slack by turning rewind crank ⑪ in direction of arrow until film is taut.
4. Close back cover by simply pressing it. When the cover is closed, the frame counter indicates S (start).
5. Advance film and release shutter twice. This winds up film exposed during loading. The first frame appears with the third advance and the frame counter indicates 1.
6. If the rewind knob turns in reverse direction when advancing film this indicates film has been properly inserted and engaged in take-up spool.

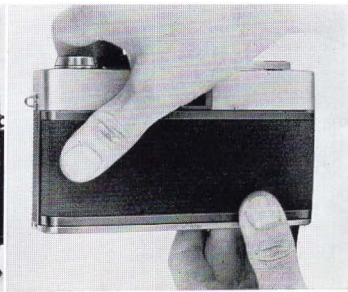
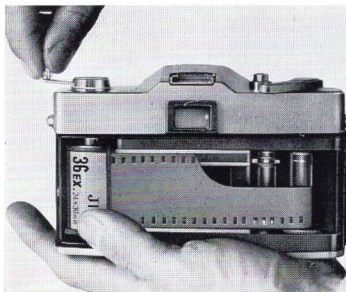

7. Any 35 mm film can be used—20 or 36 exposure, color or black and white.

FILM SPEED

Your next step is to set the proper film speed. (Film speed is printed on the box or the instruction sheet.) Press lever ⑬ and move opposite the proper ASA or DIN number. Speeds of 160 and over are marked in red . . . refer to page 12 and note precautions.

The speed scale has click stops for accurate lever setting.

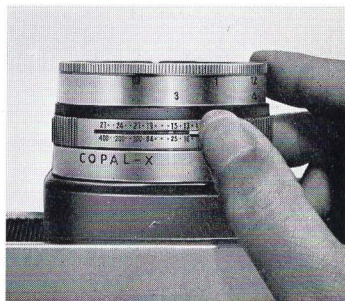

	(12)	(20)	(32)	(40)	(50)	(80)	(125)	(160)	(250)	(320)	
ASA	10	• 16	• 25	•	•	• 64	• 100	•	• 200	•	• 400
DIN	11	• 13	• 15	•	•	• 19	• 21	•	• 24	•	• 27
	(12)	(14)	(16)	(17)	(18)	(20)	(22)	(23)	(25)	(26)	

USING THE ELECTRIC EYE

1. Match **A** (Auto) mark of the aperture ring ⑦ to the index mark ①.

The aperture scale from 2.8 to 22 are not used in EE photography.

2. Setting shutter speed

Turn the shutter speed ring ⑤ and set desired speed on the index mark.

Speeds of 1/500, 1/250, 1/125, 1/60, 1/30, 1/15 and B (Bulb) are calibrated on the scale.

- B (Bulb) is not coupled to the EE mechanism. A safety device is provided so that B cannot be set by merely turning ring ⑤.
- Intermediate speeds cannot be set between marked numbers.

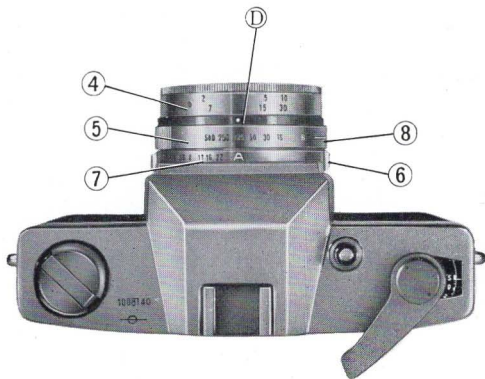

3. Focusing

Turn focusing ring ④ so that the image inside the circle of the viewfinder is sharp. For easier focusing, a micro-dia-prism is used.

● The focusing ring is calibrated in feet and meters for use in flash photography.

4. Compose the picture

There is no parallax problem—what you see in the viewfinder becomes the picture.

5. EE meter

As you view your subject on the light meter pointer can be seen at the right of the viewfinder. When the pointer is between the upper and lower warning marks, the picture will be properly exposed and the pointer indicates the F number at which

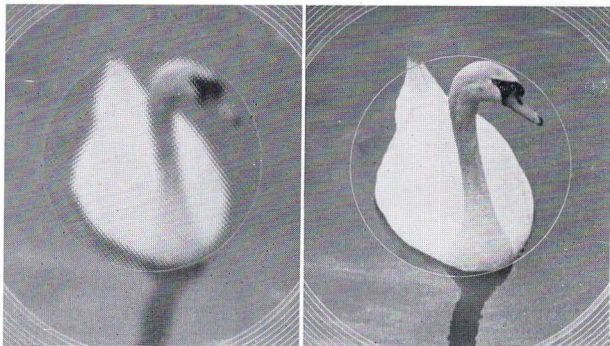

the exposure was made.

- Exposures can be made even when the pointer is within the upper or lower warning mark but over or underexposure will result.

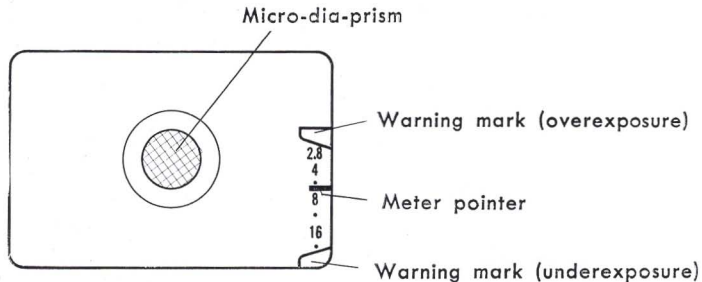

WARNING INDICATION OF SHUTTER SPEED

- The upper and lower red marks are the warning areas indicating insufficient or overexposure. When the pointer is within one of these marks, the shutter speed must be changed. When the pointer is in the upper red mark, turn the shutter speed ring ⑤ to the left (as seen from above); when it is within the lower red mark, turn the ring

to the right.

- If the pointer does not move out of the red mark even when the shutter speed ring is turned fully to left or right, it means no EE photography is possible.
- Never turn the shutter speed ring or aperture ring while the shutter button is being pressed. If this is done, EE mechanism might be damaged.
- When photographing a dark object using highly sensitive film such as ASA 200 or 400 and with speed of 1/30 or 1/15 second, insufficient exposure sometimes occurs even when the pointer is not within the warning area.

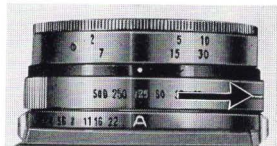
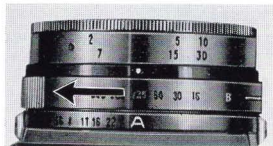
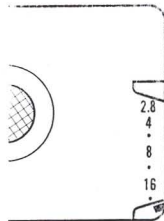
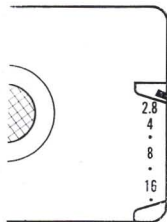

To warn the user of this, the scale over 160 is in red.

HOLDING THE CAMERA

Holding the camera steady is very important in obtaining accurately focused and sharp pictures. Hold the camera as shown in the photograph depending on horizontal or vertical picture. Determine the composition, focus at the same time and then slowly press the shutter button. The following are important:

1. Hold the camera firmly with both hands.
 2. For horizontal pictures, press both elbows against the body; for vertical pictures, hold one elbow against the body.
- Rough pressing of the shutter button causes camera to move.
 - When the shutter speed is set slower than $1/30$ second, the use of a tripod is recommended to prevent camera movement.

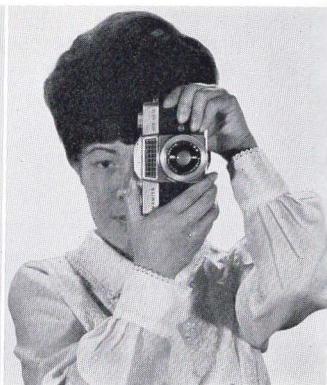

MANUAL APERTURE AND FLASH PHOTOGRAPHY

When **A** (automatic) mark is removed from the index by turning aperture ring ⑦, the EE mechanism is disengaged automatically. Then aperture selection is manual and can be set with any desired shutter speed. This method is used in both flash and bulb photography. Film advancing and other operations are the same as in the case of EE photography.

The pointer in the viewfinder now functions independently and is used in setting the proper aperture. (However, this pointer has no relationship to B photography.)

When photographing a dark object, if the meter pointer remains within the warning area even when the shutter speed ring ⑤ is turned fully to the left, change to flash.

In flash photography, the aperture is determined by the guide number of the flash bulb and the aperture is set manually.

1. Attach the flash unit to the accessory shoe and connect the cord to the flash terminal ⑩.

M and F class bulbs and electronic flash can be used.

2. The aperture is found by dividing the guide number of flash bulb used by the distance.

$$\text{Proper aperture} = \frac{\text{Guide number}}{\text{Distance}}$$

This camera is equipped with X-contact flash circuit; its synchronizing range is shown on page 15.

Type of Flash Bulb	Synchronization Range
M class	1/30 1/15
F class	1/60 1/30 1/15
Electronic flash	For all shutter speeds

B (Bulb) Photography

In B exposure, the shutter remains open as long as the shutter button ② is depressed; thus exposure time can be determined at will. This method can be used for time exposures or night scenes.

1. Turn the aperture ring from **A** (Auto) mark.
2. With the B (Bulb) set lever ⑧ depressed, turn the shutter speed ring ⑤ and set on B scale.
3. Advance the film; press the shutter button; exposure continues until the shutter button is released.
 - For extremely long exposures, use a cable with a lock.
 - B set lever ⑧ functions also as a safety device for the EE mechanism to prevent accidental B settings.



FILM REWINDING AND UNLOADING

When the end of the film approaches, a resistance is felt in advancing; stop advancing and unload the film as follows.

1. Press the rewind button ⑭ on the bottom of the camera.
2. Raise the crank of the rewind knob ⑪ and turn it in the direction of the arrow.

When the film is rewound completely, the resistance ceases.

3. Open the back cover by pulling the back cover slide lock ⑯.
4. Pull out the rewind knob and remove cartridge.

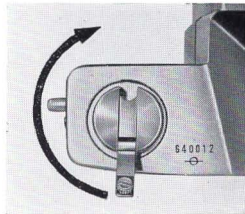
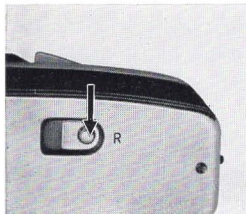

HOW TO USE FILTERS

Filters of 40.5mm fit the lens mount.

The exposure factor differs depending on the factor of each filter. In photographing, increase the exposure time by the length of time equal to the exposure factor.

ADJUSTING FOR FILTER FACTOR

1. Method that divides the ASA speed

Divide the ASA speed of the film used by the exposure factor; then re-set the film sensitivity to the value obtained.

Example: Film is ASA 100 and filter factor is 2, $100 \div 2 = 50$. After that, photograph with usual EE method. When the filter is removed, be sure to set the film speed on its former number.

2. Method that changes the aperture

Read the aperture value with the meter pointer within the viewfinder.

Detach the aperture ring ⑦ from **A** (Auto) and set the aperture at a value which is less by the filter factor.

Example: Since the aperture values are in multiple order, when the filter factor is two times, setting is made skipping one step and when it is four times, setting is made skipping two steps. For example, when a filter with factor of two is used, setting is made at F8; When the filter is three, setting is made between F8 and F5.6. In this case, photographing is by manual aperture control photography.

HELPFUL HINTS

The Auto-Lux 35 is a precision instrument. Reasonable care will assure trouble free use for many years.

1. Do not tamper with camera interior when loading film.
2. Keep lens clean. Use photographic lens paper or soft lint-free cloth.
3. Use of UV filter is a good practice as a cover for the lens to prevent accidental damage. This filter can be left on the camera at all times.
4. If camera is not to be used for a long time, remove film, release shutter and store in a dry place.
5. Never leave your camera lens exposed to direct sun light. Do not keep camera in hot storage areas like the trunk of your automobile or glove compartment.

YOU ARE ON YOUR WAY TO BETTER PICTURES you own a MAMIYA AUTO-LUX 35!

MAMIYA CAMERA CO., LTD.

No. 7, 1-CHOME, HONGO, BUNKYO-KU, TOKYO, JAPAN



PRINTED IN JAPAN