

# More picture-taking capabilities for Universal and Press 23 cameras

## MAMIYA LENSES and ACCESSORIES

With the expanded lineup of 9 interchangeable lenses to draw upon, the Mamiya 23 user enjoys greater-than-ever pictorial control. And he can depend on the critical definition and superb color correction of these Mamiya-Sekor optics to produce consistently high quality pictures.

Each lens is mounted in a helical focusing system and fitted in M-X synchro shutter with speeds from 1 second to 1/500th, plus B. Shutters can be locked "open" for ground-glass viewing. All can be used with any Mamiya 23 camera, except the 250mm f5 which is designed for use only with the Universal and Super 23. Lens hood is included with all lenses except 65mm and 75mm.

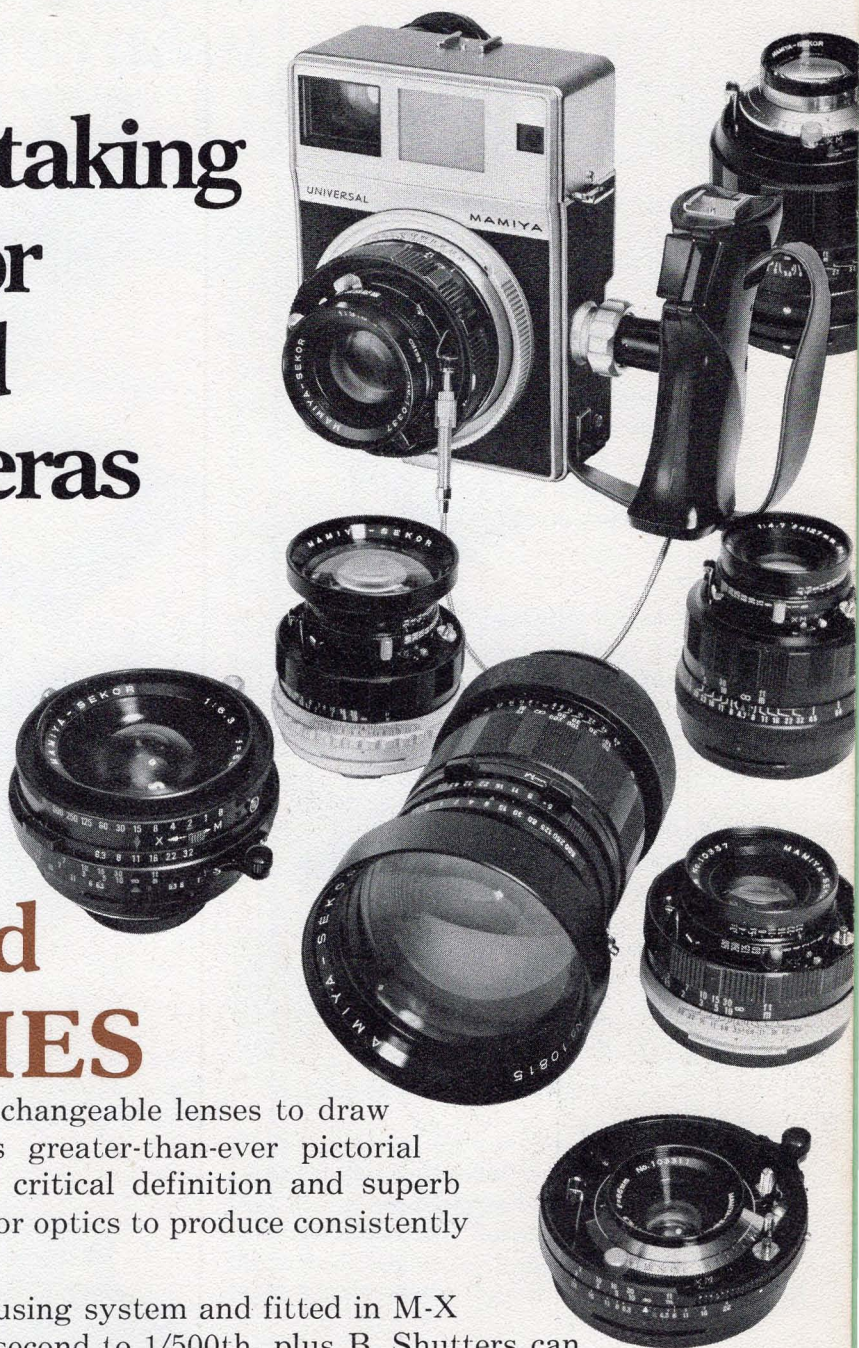

Lens	Catalog No.	Angle of view			Closest focus*	Filter size
		2¼ x 2¾	2¼ x 3¼	Polaroid		
50mm f6.3†	60106	82°	90°	—	3.3 feet	72mm
65mm f6.3†	60100	68°12'	75°30'	—	3.5 feet	43mm
75mm f5.6	60108	61°	68°	77°	3.5 feet	72mm
100mm f3.5	60105	47°36'	53°36'	—	3.5 feet	55mm
100mm f2.8	60103	47°36'	53°36'	—	3.5 feet	72mm
127mm f4.7	60109	38°40'	43°30'	50°50'	5 feet	55mm
150mm f5.6	60102	32°42'	37°12'	—	7 feet	55mm
250mm f8**	60107	20°10'	22°50'	—	12 feet	55mm
250mm f5‡	60104	20°10'	22°50'	—	8 feet	105mm

\*without extension tubes

†supplied with auxiliary optical finder

\*\*not rf-coupled

‡for Mamiya Universal and Super 23 only

# ACCESSORIES FOR MAMIYA UNIVERSAL

Focusing Back

G Adapter Back

M Adapter Back

P Back

### Optical Finder P

(Product No. 60783) Fits camera accessory shoe. Shows coverages of Polaroid format with 75, 100 and 127mm lenses as luminous outlines. Built-in parallax correction.



### Tetraphoto Prism Lens Attachment

(Product No. 60455) For identification photos and similar applications. Used with 127mm lens to produce simultaneously 4 images of subject on Polaroid format. Includes mask insert for exposing selected film areas if desired.

**Focusing Back** (Product No. 60781) Fits directly onto Universal camera body. Comprises Fresnel-type ground-glass panel and detachable folding hood. Entire ground glass area is used for Polaroid format; rollfilm 6x9 and 6x7 formats are shown as outlines. After framing and focusing, back is removed and replaced with either P back or M adapter and rollfilm holder for photography.

**M Adapter Back** (Product No. 60778) Permits use of any Mamiya rollfilm holder as well as Mamiya ground-glass back, sheet film and filmpack holders.

**G Adapter Back** (Product No. 60779) Provides facility for using Graflok-type film holders and ground-glass attachment.

**P Back** (Product No. 60780) Complete holder for Polaroid series 100 film packets. Full coverage of 3x3 3/4" picture area is obtained with 127mm and 75mm lenses; other lenses produce slight vignetting of corners. Supplied with dark slide.

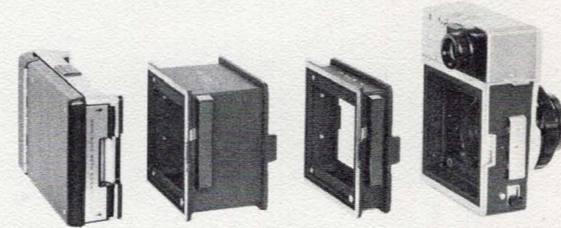

### Back Extension Spacer Set

(Product No. 60453) For closeup photography. Comprises two spacers that fit between Universal camera body and any of 3 backs. Spacers may be used individually or in combination for magnifications up to 1.51x (with 75mm lens).



### 1:1 Copying Outfit

Consists of camera support frame, set of 4 legs, leg extensions and vinyl mat showing coverages of 2 1/4 x 2 3/4, 2 1/4 x 3 1/4 and Polaroid formats with 75mm, 100mm and 127mm lenses. Used in conjunction with Back Extension Spacers.

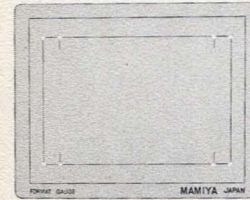

### Polaroid Format Guide

(Product No. 60782)

Clear plastic plate with etched outlines showing areas of

Polaroid, 6x9 and 6x7; also has small holes at corners of two latter formats. When placed on Polaroid picture, permits selection of desired 2 1/4 x 3 1/4 or 2 1/4 x 2 3/4.

### Tripod Adapter P

(Product No. 60721)

For mounting Universal with Polaroid back on tripod for horizontal-format shots. Attaches to bottom tripod socket of camera.



### Quick-Shoe Adapter

(Product No. 60438) Accepts Tripod Adapter P for quick on/off tripod mounting.

### Polaroid Finder Mask

(Product No. 60752)

Attaches to front of camera finder housing. Shows Polaroid coverage with 150 and 250mm lenses (has removable insert for latter). Does not interfere with rangefinder.



### 127mm Finder Mask

(Product No. 60751) Similar to No. 60752, but shows 6x9/6x7 coverage with 127mm lens. May also be used with Super 23.

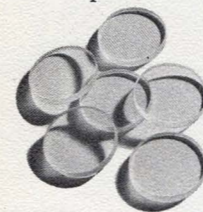

### Dioptric Correction Lenses

Screw-in mounted to fit eyepiece of Universal and Super 23. Available in 7 diopter powers, from -4 to -3.

### Compartment Case

(Product No. 60452) Finest leather, black finish, with shoulder strap. Holds camera, lenses and accessories securely in separate compartments.



## Accessories for All Mamiya 23 Cameras MAMIYA BACK ACCESSORIES\*

**Rapid Rollfilm Holder A 6x9** (Product No. 60603) Accepts 120 and 220 film interchangeably; gives 8 (2 1/4 x 3 1/4) exposures with 120, and 16 with 220 film. Has rapid-advance lever and auto-reset counter adjustable for 8 and 16 exposures, respectively.

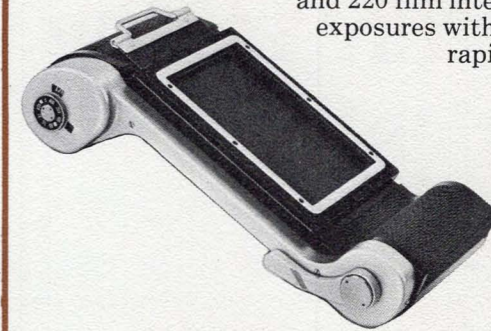

**Rapid Rollfilm Holder B 6x7** (Product No. 60604) Same as A, but gives 10 (2 1/4 x 2 3/4) exposures with 120, and 20 with 220 film.

**Ground Glass Back & Focusing Hood** (Product No. 60775) Accepts sheet film/plate holders and film pack adapter in spring-loaded compartment.

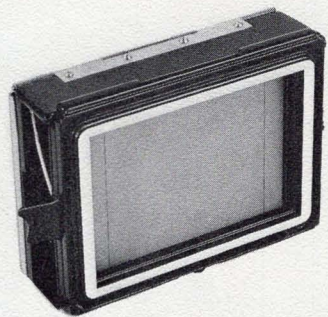

**Sheet Film/Plate Holder** (Product No. 60610) Fits into ground glass back, uses 2 1/4 x 3 1/4 emulsions.



### Film Pack Adapter

For standard 520 packs. Fits into ground-glass back.



### Right-angle Focusing Back

(Product No. 60718) Permits ground-glass viewing and focusing from above, below or either side. Especially valuable for copying and closeup work. Embodies magnifying eyepiece, right-angle mirror and ground-glass panel. Supplied with case.



**Eyelevel Focusing Hood** (Product No. 60774) Attaches to Mamiya ground-glass back, shields finder image from extraneous light. Fits any camera with Mamiya back. Supplied with case.



# GENERAL ACCESSORIES

## For all Mamiya 23 Cameras

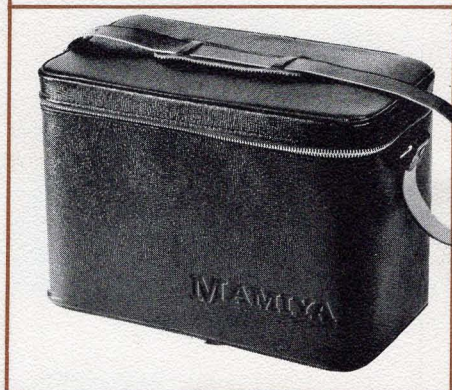
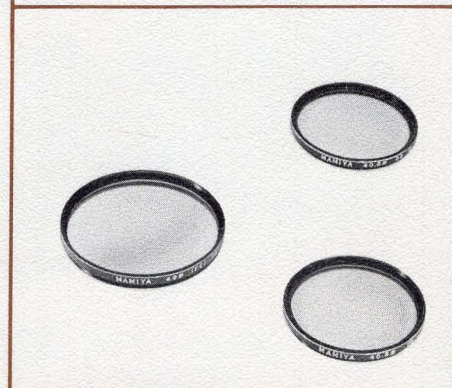
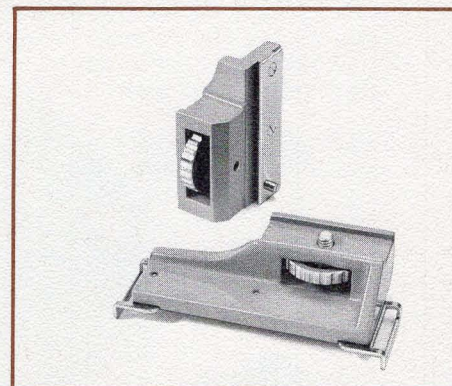
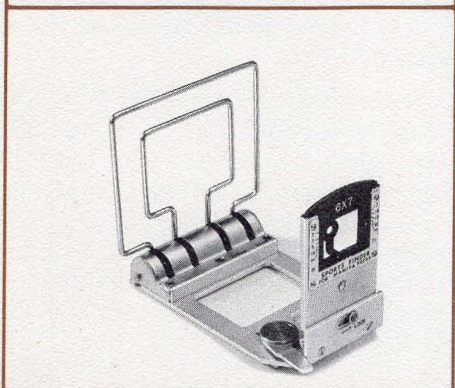

**Extension Tube Set** (Product No. 60650) For closeup photography with any Mamiya 23, using any lens up to 150mm. Comprises 5 tubes which may be used in various combinations. With 100mm f3.5 lens, reproduction ranges from 1/9 to 1.14x.

**Sportsfinders** Folding-frame finders fit onto camera accessory shoe.  
 Product No. 60714 (6x9) with 100, 150 & 250 lens fields, for Universal and Super 23  
 Product No. 60715 (6x7) same as No. 60714, except for picture format

**Carry-All Bag** (Product No. 60451) Luxurious leather bag with shoulder strap. Partitioned to hold any Mamiya 23 camera, accessories and film.

**Tripod Adapter** (Product No. 60722) Permits camera to be mounted on tripod for vertical shots. Screws onto grip holder socket after holder is detached.

**Flashgun Brackets** For attaching press-type flash units to socket on side of camera opposite grip handle.  
 Model G (Product No. 60651) for Graflite fitting  
 Model H (Product No. 60652) for Heiland "E" fitting

**Optical Glass Filters** Ground and polished to optical flatness and hard-coated. Wide variety available, in screw-in mounts to fit all lenses.

Specifications subject to change without notice